

THIS DOCUMENT CONTAINS PROPRIETARY INFORMATION WHICH IS THE PROPERTY OF QSC, LLC. THAT MAY NOT BE DISCLOSED, REPRODUCED OR USED WITHOUT EXPRESS WRITTEN CONSENT FROM QSC, LLC.

REVISIONS			
REV	DESCRIPTION	BY	DATE
A	RELEASE FOR SALES AND MARKETING	ES	12-JUL-17

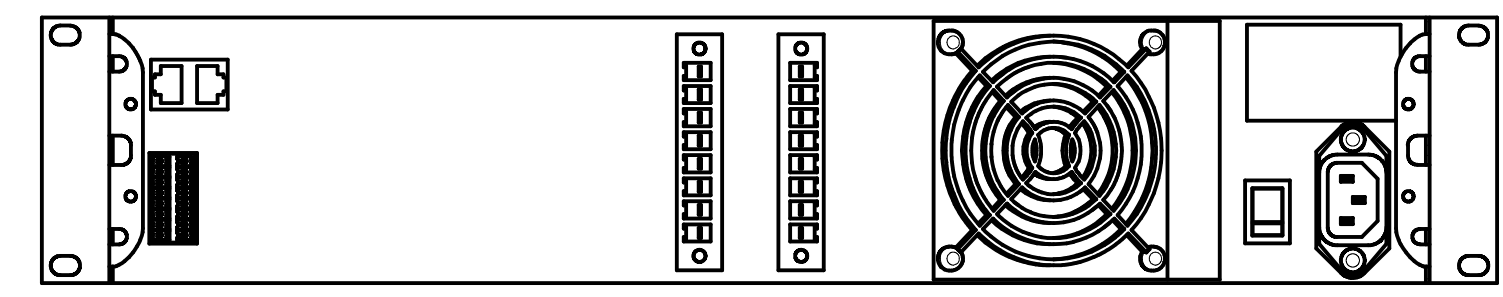
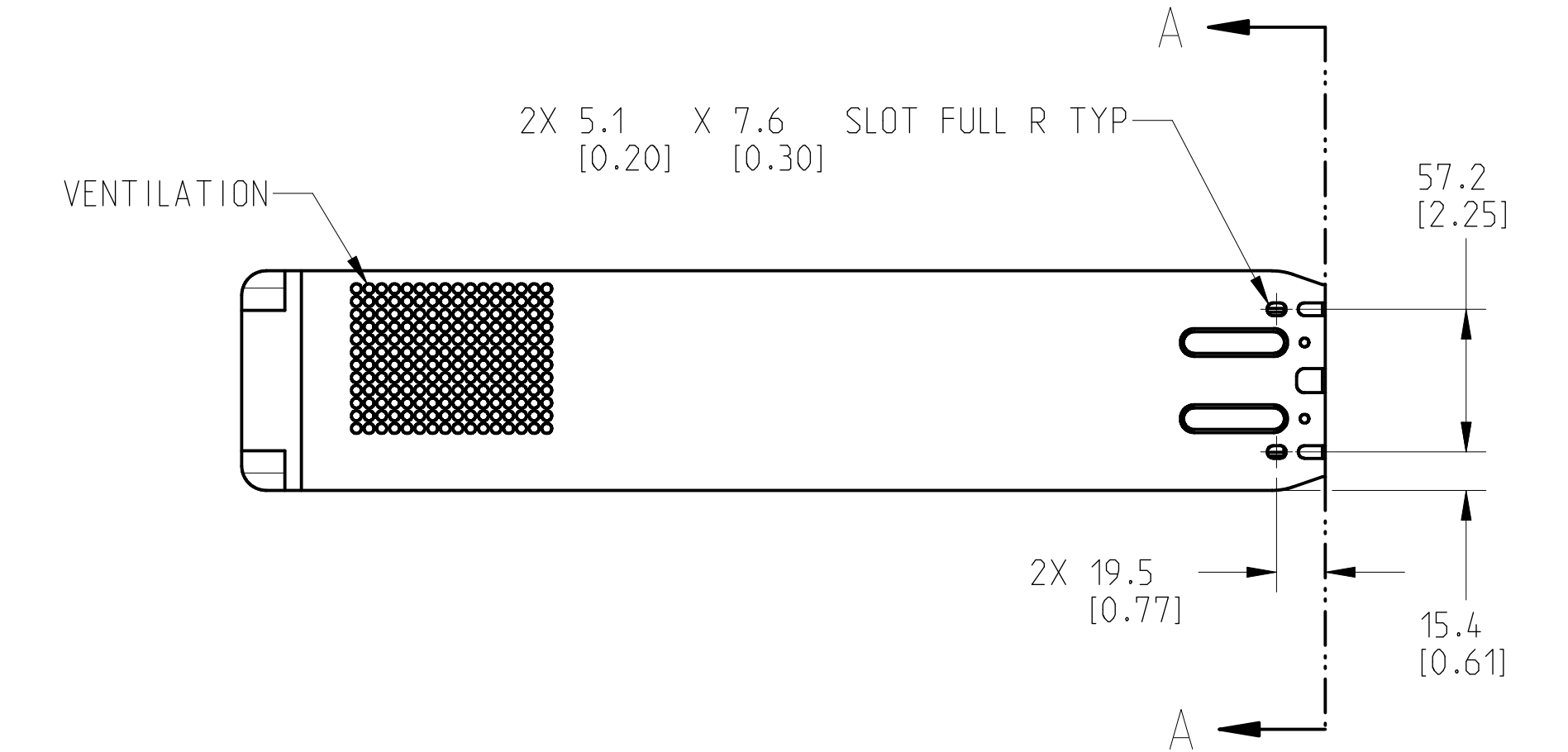
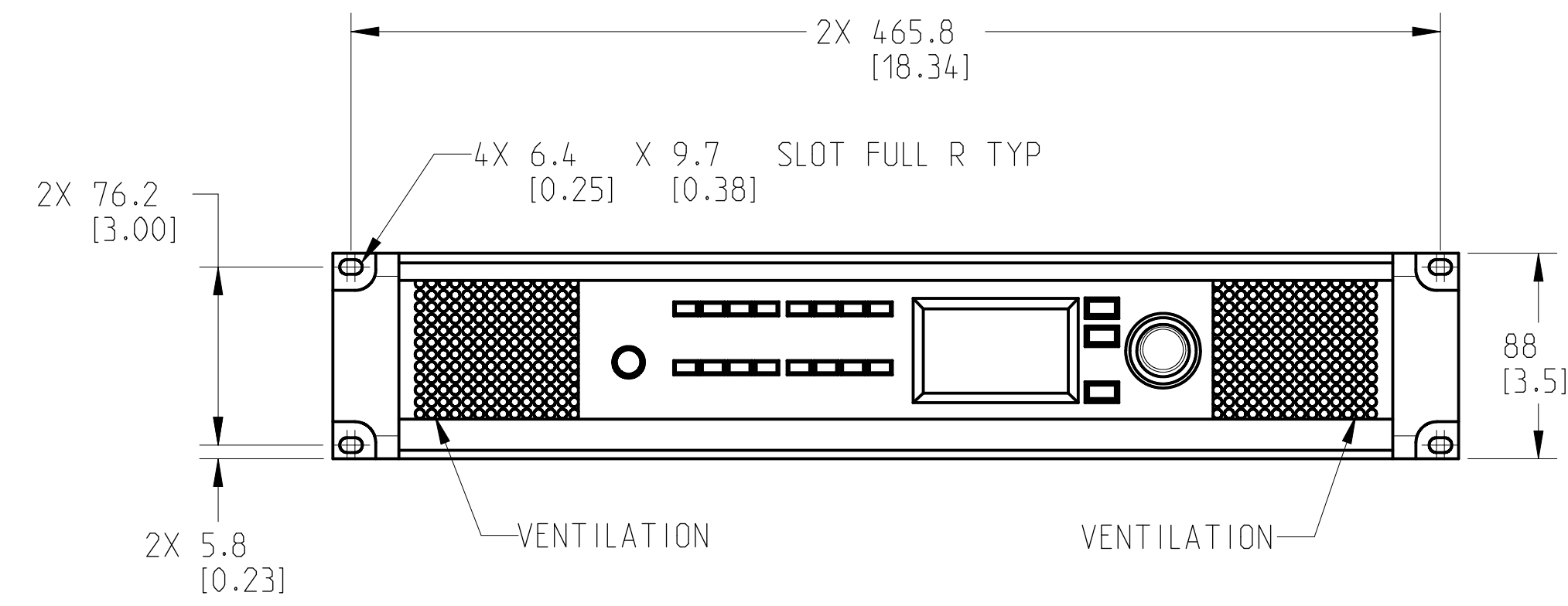
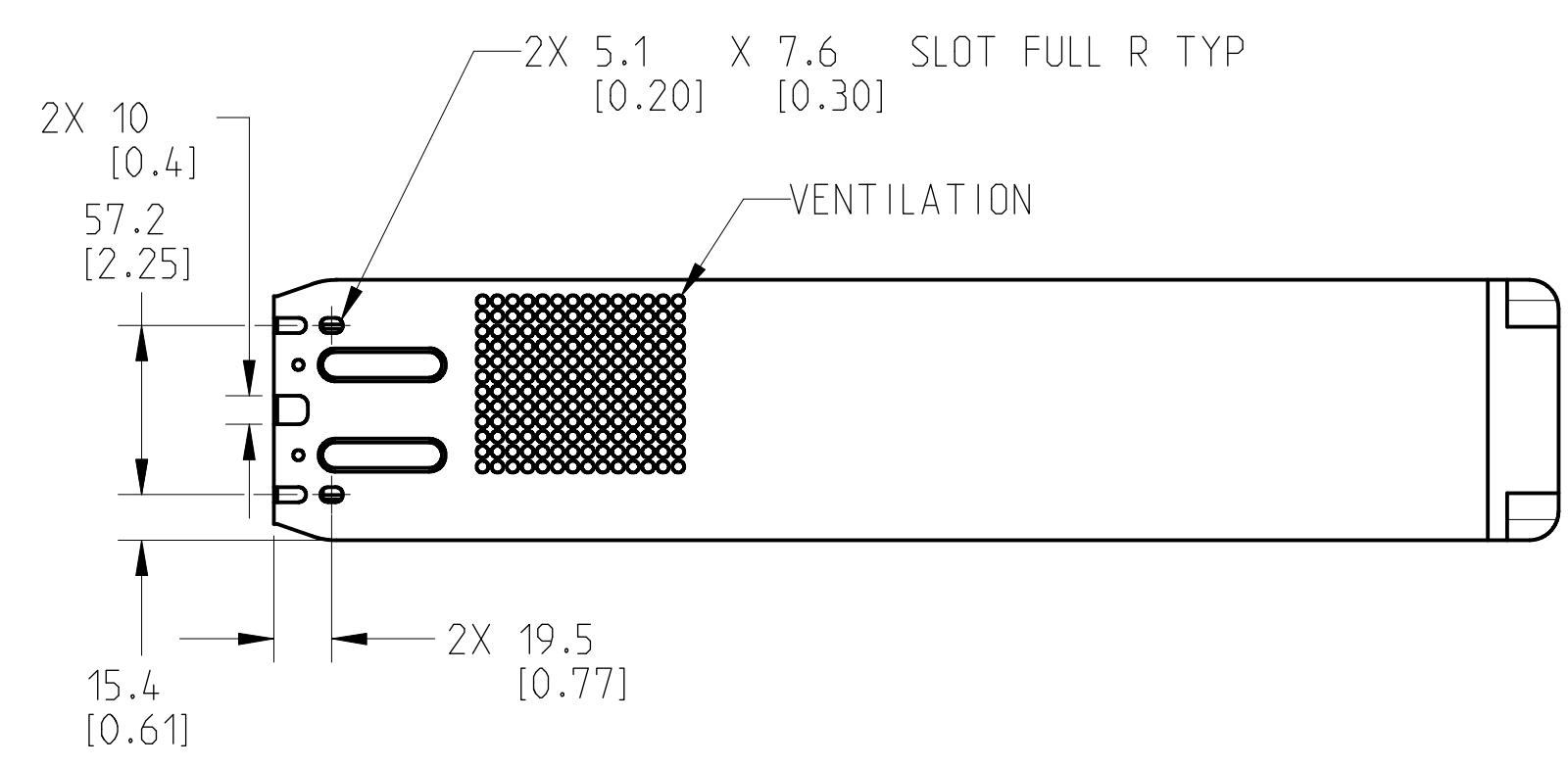
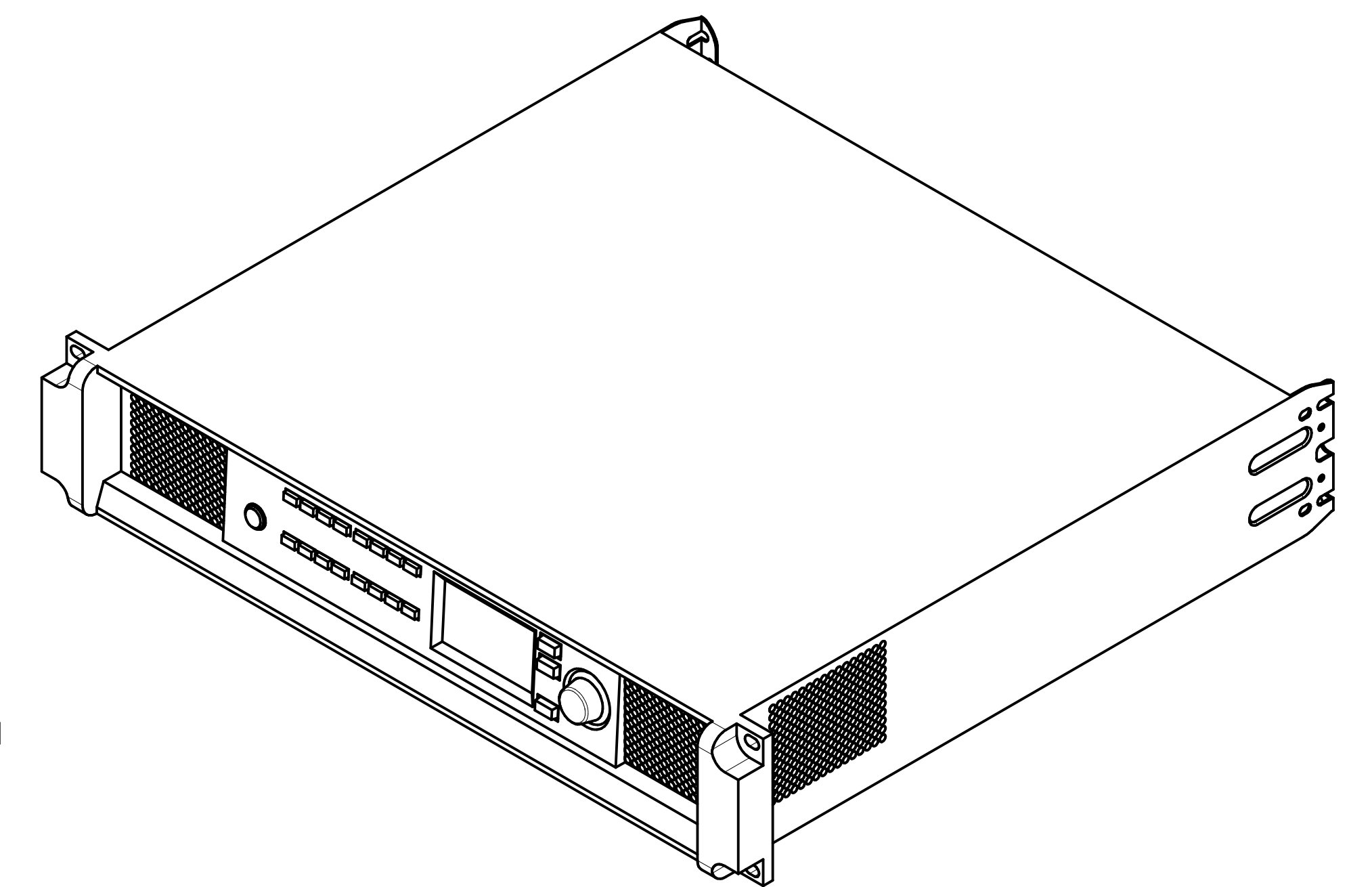
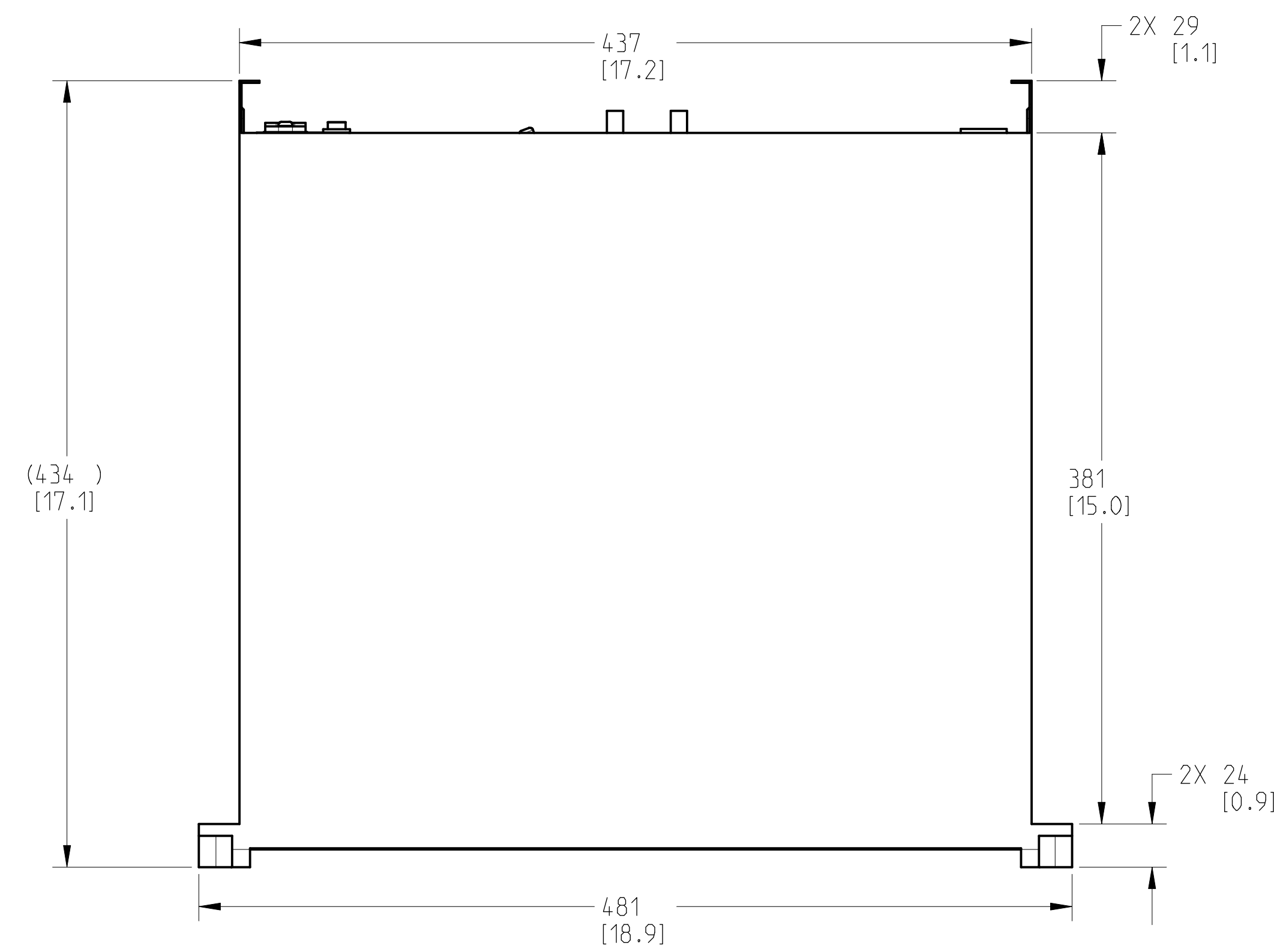

VIEW A-A
REAR VIEW

- 3. DIMENSIONS ARE IN MILLIMETERS [INCH].
- 2. TOLERANCES (MM): X ± 3, ANGLES: ± 1°.
- 1. NET WEIGHT APPROXIMATELY 11.4 KG [25.1 LBS].

NOTES: UNLESS OTHERWISE SPECIFIED

UNLESS OTHERWISE SPECIFIED DIMENSIONS IN MILLIMETERS (IN) TOLERANCES ARE: DECIMALS DECIMALS ANGLES .X±.5(.02) .XX±.25(.01) ± 1/2 DECURR EDGES .25 (1.01) R MAX MATERIAL FINISH	DESIGNER ENG. SERVICES	QSC, LLC 1675 MACARTHUR BOULEVARD COSTA MESA, CA 92626	FINISHED, AMPLIFIER, CXD 8.8QN SERIES, 100-240V, E005		
	ENGINEER		TECHNICAL DIRECTOR	MANUFACTURING ENGINEER	
	DRAWING INFO: FS-220125-ZD-A.1	MODEL INFO: FS-220125-3D-A.1	SIZE D	CAGE CODE 00PW4	DRAWING NO. FS-220125-2D
	SCALE: 0.400	DO NOT SCALE DRAWING	SHEET 1 OF 1	REV A	1