



# Synapse D32i

## Dante™/AES67 Network Audio Interface - 32 Line Level Analog Inputs



### User Manual

1675 MacArthur Boulevard · Costa Mesa, CA 92626  
Ph: 800/854-4079 or 714/957-7100 · Fax: 714/754-6174

© 2020 QSC, LLC all rights reserved. QSC and the QSC logo are registered trademarks of QSC, LLC in the U.S. Patent and Trademark office and other countries. All other trademarks are the property of their respective owners. Patents may apply or be pending.

[www.qsc.com](http://www.qsc.com)

614-0003939

## IMPORTANT SAFETY INSTRUCTIONS

The symbols below are internationally accepted symbols that warn of potential hazards with electrical products.



This symbol, wherever it appears, alerts you to the presence of un-insulated dangerous voltage inside the enclosure -- voltage that may be sufficient to constitute a risk of shock.



This symbol, wherever it appears, alerts you to important operating and maintenance instructions in the accompanying literature. Please read the manual.

1. Read these instructions.
2. Keep these instructions.
3. Heed all warnings.
4. Follow all instructions.
5. Do not use this apparatus near water.
6. Clean only with a dry cloth.
7. Do not block any ventilation openings. Install in accordance with the manufacturer's instructions.
8. Do not install near any heat sources such as radiators, heat registers, stoves, or other apparatus (including amplifiers) that produce heat.
9. Do not defeat the safety purpose of the polarized or grounding-type plug. A polarized plug has two blades with one wider than the other. A grounding type plug has two blades and third grounding prong. The wider blade or the third prong is provided for your safety. If the provided plug does not fit into your outlet, consult an electrician for replacement of the obsolete outlet.
10. Protect the power cord from being walked on or pinched particularly at plugs, convenience receptacles, and the point where they exit from the apparatus.
11. Only use attachments/accessories specified by Attero Tech
12. Use only with the cart, stand, tripod, bracket, or table specified by the manufacturer, or sold with the apparatus.
13. When a cart is used, use caution when moving the cart/apparatus combination to avoid injury from tip-over.
14. Unplug this apparatus during lightning storms or when unused for long periods of time.
15. Refer all servicing to qualified service personnel. Servicing is required when the apparatus has been damaged in any way, such as power-supply cord or plug is damaged, liquid has been spilled or objects have fallen into the apparatus, the apparatus has been exposed to rain or moisture, does not operate normally, or has been dropped.
16. This apparatus shall be connected to a mains socket outlet with a protective earthing connection.
17. When permanently connected, on all-pole mains switch with a contact separation of at least 3mm in each pole shall be incorporated in the electrical installation of the building.
18. If rack mounting, provide adequate ventilation. Equipment may be located above or below this apparatus but some equipment (like large power amplifiers) may cause an unacceptable amount of hum or may generate too much heat and degrade the performance of this apparatus,
19. This apparatus may be installed in an industry standard equipment rack. Use screws through all mounting holes to provide the best support.



TO REDUCE THE RISK OF FIRE OR ELECTRIC SHOCK, DO NOT EXPOSE THIS APPARATUS TO RAIN OR MOISTURE.

## WARRANTY INFORMATION

For a copy of the QSC Limited Warranty, visit the QSC website at [www.qsc.com](http://www.qsc.com)

Note: This equipment has been tested and found to comply with the limits for a Class A digital device, pursuant to Part 15 of the FCC Rules and EN55022. These limits are designed to provide reasonable protection against harmful interference when the equipment is operated in a commercial environment. This equipment generates, uses, and can radiate radio frequency energy and, if not installed and used in accordance with the instruction manual, may cause harmful interference to radio communications. Operation of this equipment in a residential area is likely to cause harmful interference, in which case the user will be required to correct the interference at their own expense.



This symbol means the product must not be discarded as household waste, and should be delivered to an appropriate collection facility for recycling. Proper disposal and recycling helps protect natural resources, human health and the environment. For more information on disposal and recycling of this product, contact your local municipality, disposal service, or the business where you bought this product.

# Contents

<b>1 - Overview</b>	<b>5</b>
<b>2 - Device Installation</b>	<b>7</b>
2.1 - Mounting	7
2.2 - Audio Wiring	7
2.2.1 - Unbalanced Output to an Balanced Input	7
2.3 - Power Supply	8
2.4 - Network Connections	8
2.4.1 - AES67 Audio Network Note	8
2.4.2 - Using on a Redundant Network	8
2.4.3 - Using on Standalone Network	9
<b>3 - Device Operation</b>	<b>10</b>
3.1 - Display View Operation	10
3.1.1 - Bank Metering Views	10
3.1.2 - Channel Metering Views	10
3.1.3 - Dante Monitor View	10
3.1.4 - Network Info View	10
3.1.5 - Dante Info View	11
3.1.6 - Version View	11
3.1.7 - No Network	11
3.1.8 - Identify	11
3.2 - Headphone monitoring	11
3.2.1 - Headphone Volume	11
3.2.2 - Headphone Mute	11
3.3 - Factory Reset	11
3.4 - Firmware Updates	11
3.5 - Third Party Control	11
<b>ARCHITECTS &amp; ENGINEERS SPECIFICATION</b>	<b>12</b>
<b>Device Specifications</b>	<b>13</b>

## 1 – Overview

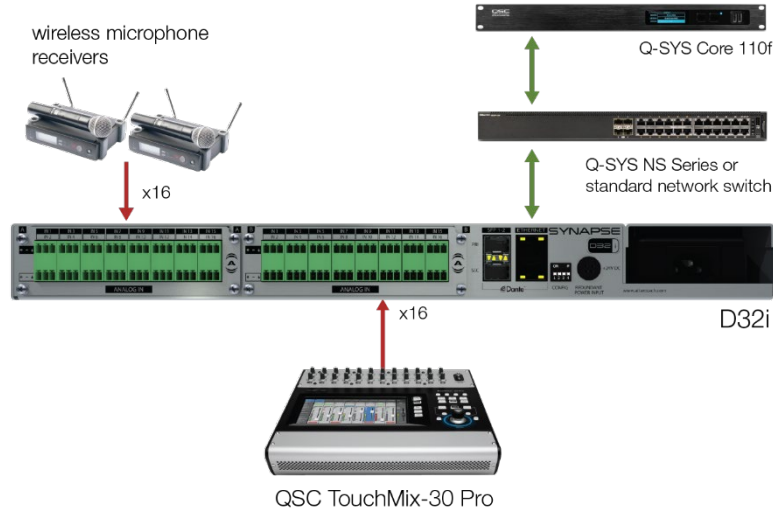

The Synapse D32i is a 1RU high-density Dante break-in interface. Featuring 32 line-level balanced inputs, the Synapse D32i is designed to address the needs of a wide array of commercial audio connectivity applications and venues requiring high density, high performance analog to Dante conversion.

The 32 inputs feature high performance analog to Dante conversion and is available with terminal block connector options to facilitate ease of use in live and touring sound as well as fixed install commercial applications and each of the two banks of 16 inputs has a software configurable pad allowing each to be configured to either professional (+4dBu) or consumer (-10dBV) nominal input levels.

The front panel features an accessible integrated headphone amp and a high contrast OLED display to provide quick and detailed feedback for audio confidence monitoring and diagnostics.

The 24V power supply comes pre-mounted to the D32i chassis but there is also support for a secondary external 24V DC supply for optional power redundancy.

On the network side, there is a fully redundant Dante interface utilizing both RJ45 connectors and SFP ports. The SFP ports allow the D32i to utilize direct fiber connectivity for long range signal extension in physically large systems such as arenas, large corporate buildings and convention centers.

Audinate's Dante™ Controller or other 3rd party manufacturer's Dante™ routing software can be used to control the Dante™ audio routing configuration of the device while the [Attero Tech unIFY Control Panel](#) application can be used to configure the device-specific features.

### 1.2 – What's in the Box

The Synapse D32i comes supplied with the following:

- Synapse D32i device
- AC Mains power cord

### 1.3 – Optional Extras

The following are available as options for the Synapse D32i and may be ordered separately:

- 24V DC Redundant Power Supply ( P/N: 256-00014-01)
- 1Gbit Fiber SFP Module ( P/N: 065-00038-01)

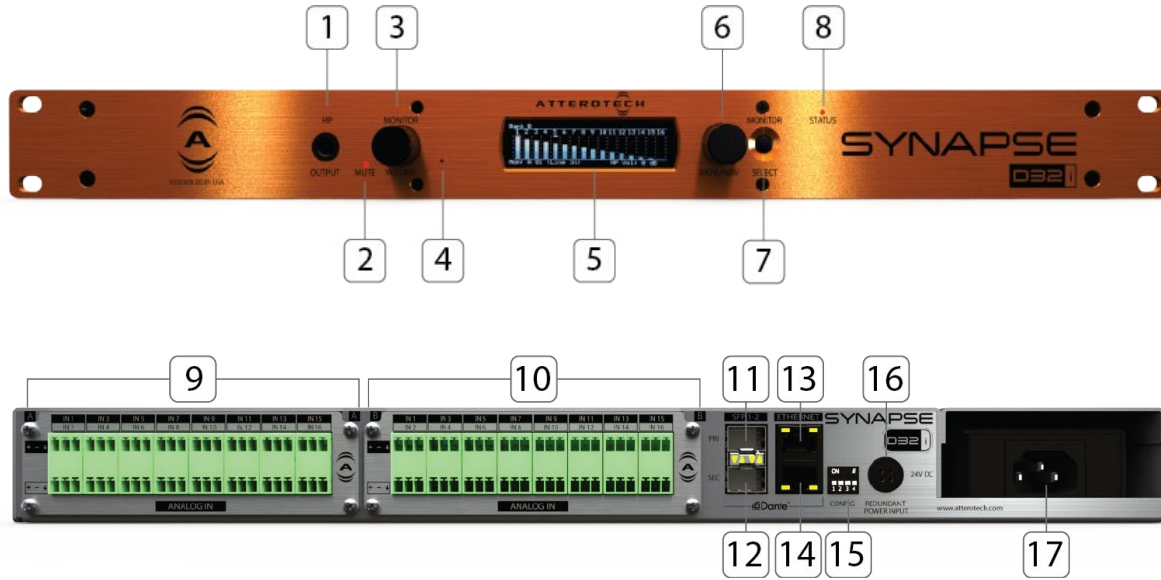

Terminal  
Block  
Option

## DEVICE FEATURES

### FRONT PANEL

- 1 - Headphone Jack
- 2 - Headphone Mute Indicator
- 3 - Headphone Volume/Mute Knob
- 4 - Factory Reset Switch
- 5 - OLED Display
- 6 - Front Panel Nav Knob
- 7 - Monitor Select Switch
- 8 - Device Power/Status LED

### REAR PANEL

- 9 - Bank A (Input 1-16)
- 10 - Bank B (Inputs 17-32)
- 11 - SFP port (Primary)
- 12 - SFP (Secondary) 9 - Bank A (Input 1-16)
- 10 - Bank B (Inputs 17-32)
- 11 - SFP port (Primary)
- 12 - SFP (Secondary)
- 13 - Ethernet Port (Primary)
- 14 - Ethernet Port (Secondary)
- 15 - DIP Switches (Future Use)
- 16 - Redundant Power Input
- 17 - Primary Power Supply

**\*Note:** The Synapse D32i has a label on the base of the unit that shows the device's MAC address. This is important for initial device identification as the last six digits make up part of the device's default network name that is shown when the device is detected by Dante® Controller of unIFY Control Panel.

## 2 – Device Installation

### 2.1 – Mounting

The case for the D32i is designed ready to fit in a standard 19" rack. The rack mount tabs are built in to the front panel of the unit (rack screws are not supplied). Use four screws to secure the unit to the rack. Dimensioned drawings can be downloaded from the Documents section of the [Synapse D32i product page](#).

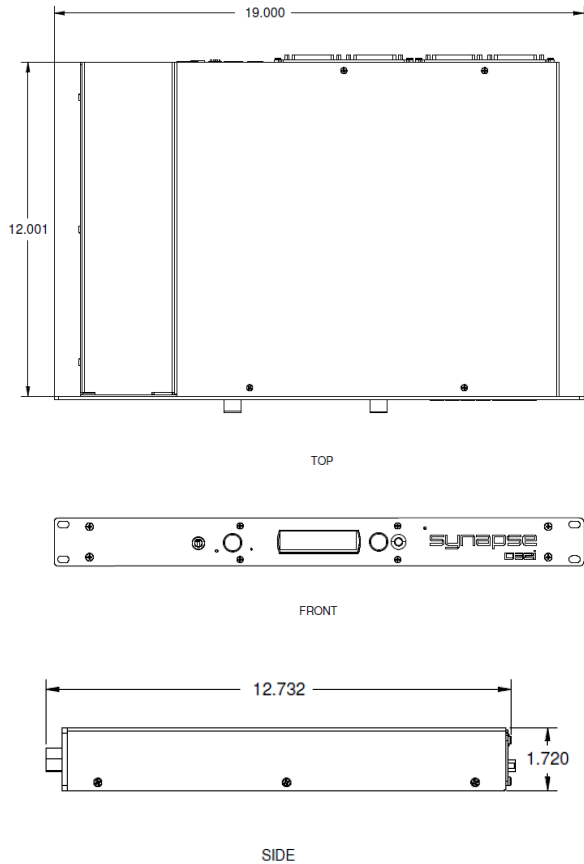

Figure 1 – Mounting and Dimension Information

### 2.2 – Audio Wiring

All connections to the Synapse D32i should be made before the power is applied. Attach audio sources that will be used to the analog audio inputs. The analog audio inputs are balanced, so be sure to check what output type the source to be connected uses in order to find how to connect it correctly.

#### 2.2.1 – Unbalanced Output to an Balanced Input

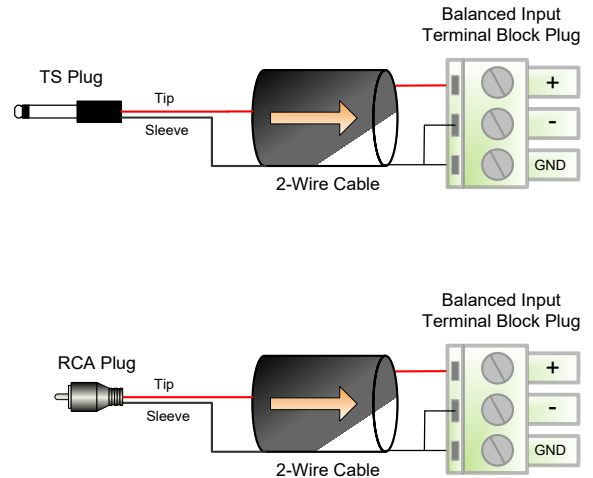

Figure 2 – Unbalanced Wiring Guide

## 2.3 – Power Supply

Use the provided AC power cable to connect a standard AC outlet to the power supply input connector. There is no “on” switch so the unit will power up as soon as the power connection is made.

*\*Note: If using the optional backup supply, avoid connecting a powered supply to the unit. It is recommended to attach the power supply to the D32i first, then connect the power cord to the power supply to supply power to it.*

Once powered, the screen on the front of the unit should turn on and show the Attero Tech logo, the status LED should be red and the mute LED should be flashing red rapidly. Initialization can up to 20 seconds depending on how the device is setup. Once initialized, the status LED will turn green, the mute LED will go out, and the screen will change to show the first of the metering screens.

There may also be some activity on the Dante RJ45 Ethernet connector LEDs. If a cable is connected and no network is detected, both LEDs will remain off. If an active connection is made the green LED will come on and the yellow LED will flash.

## 2.4 – Network Connections

*\*Note: All Attero Tech products are tested using UTP cabling and it is recommended that UTP cabling be used when installing them. STP cabling can be used for installation though care must be taken not to introduce grounding issues into the system by doing so.*

Network connection is made using the RJ45 ports and SFP ports. To use an SFP port, a suitable SFP module(s) will be required to be installed. These are not included with the D32i and must be purchased separately. In general, any 1Gbit SFP compatible module may be used.

*\*Note: If there is no network connection, the front panel will show “No Network” in the center of all the metering screens. The network screen will also indicate that there are no active interfaces.*

Dante networks can be configured in two different ways: standalone or redundant. The Synapse D32i can be used in either configuration. By default the D32i is set to “Redundant” mode but this can easily be changed using Dante Controller.

### 2.4.1 – AES67 Audio Network Note

For successful deployment of Attero Tech’s AES67 enabled products, it is necessary to insure the AES67 audio network is properly configured. As setup needs may vary by product, it may also be necessary to check with the AES67-enabled product manufacturer as well.

### 2.4.2 – Using on a Redundant Network

The D32i is setup for use in a redundant network out of the box. In this mode the D32i effectively has two separate network connections, each with its own unique IP address. Both IP addresses also need to be on completely different subnets.

By default, both ports of the D32i in redundant mode will get their own IP from a DHCP server if one is available. If not, the interfaces will fall back to a local link address. For the primary port, that will be in the range 169.254.x.x. For the secondary port, that will be in the range 172.31.x.x. Static addresses may be assigned to one or both interfaces using Dante Controller.

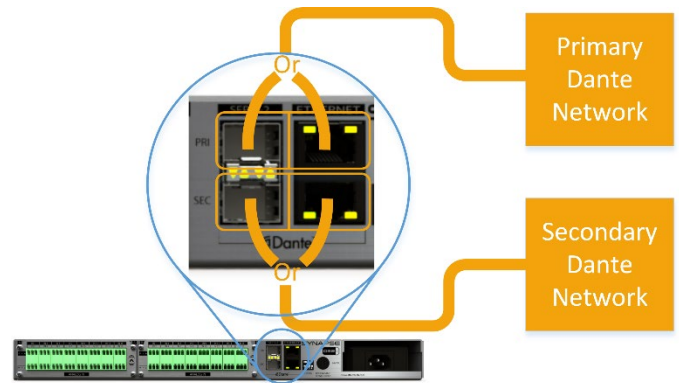

Figure 3 – “Redundant” mode, no daisy chain

Connecting both the primary and secondary connections of any Dante device to a network setup for redundancy *\*WILL\** cause network problems if the device not configured in “Redundant” mode. As only the primary interface is required for initial setup, if there is any doubt as to what configuration *\*ANY\** device on the network has, it is recommended only the primary ports of all devices be connected to the primary network and all secondary port connections are left disconnected. Once all devices that support redundancy are confirmed as being configured in “Redundant” mode, the secondary ports of all the Dante devices can then be attached to the secondary network.

For the D32i, when connecting the primary Dante network, either the primary SFP port or the primary RJ45 port can be used. Similarly, when connecting the secondary Dante network, either the secondary SFP port or the secondary RJ45 port can be used.

*\*Note: The connections to the primary and secondary Dante networks don’t have to use the same type of port on the D32i. They may be mixed so using a primary SFP connection and an RJ45 secondary connection or vice versa are both perfectly acceptable.*

Once connections to the main primary and secondary networks have been made, the unused ports can be used to create a daisy chain to a nearby device. Simply connect the spare primary port to the primary port of the nearby device. To maintain full redundancy, the spare secondary port should also be connected to the secondary port of the nearby device.

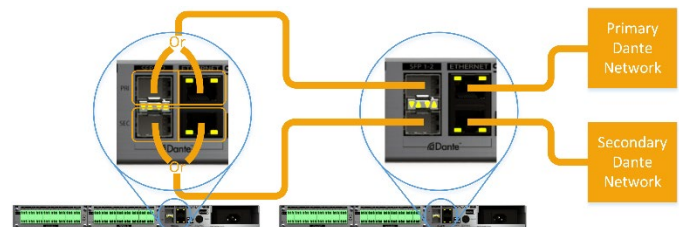

Figure 4 - “Redundant” mode with daisy chaining

*\*Note: There are limitations using daisy chaining due to the additional switch hops of a daisy chained switch/device in a Dante network. While daisy chaining can certainly offer the installer some benefits, careful consideration should be given as to whether daisy chaining is suitable for any given application.*



### 2.4.3 – Using on Standalone Network

The D32i supports both redundant mode and standalone mode (indicated as “switched” mode in Dante Controller). If the D32i is being used in a standalone network, running the D32i in either “Redundant” or “Switched mode is perfectly acceptable and will work so even though the D32i is setup in “Redundant” mode by default, it can and will work happily in a standalone network without changing anything. However, only the primary SFP port or primary Ethernet port of the D32i may then be connected to a standalone Dante network.

*\*Note: Connecting either secondary port to a standalone Dante network while the D32i is still set in “Redundant” mode will cause problems due to the IP address setup of the secondary ports having completely different IP addresses. Therefore this should be avoided.*

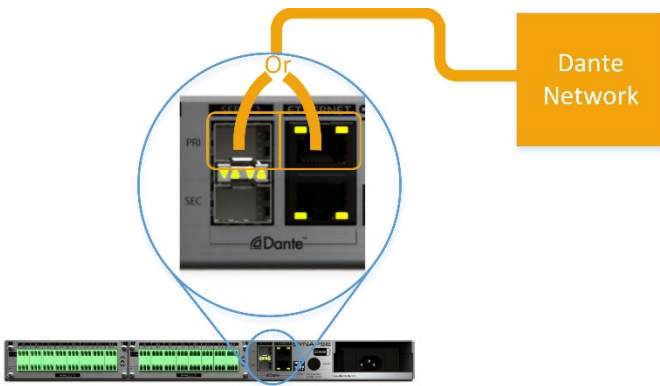

**Figure 5 - "Standalone" connection in "Redundant" mode**

For full flexibility in a standalone network, the D32i should be reconfigured to “Switched” mode. This is easily done by connecting one of the primary ports to the standalone Dante network and then using Dante controller to switch the mode.

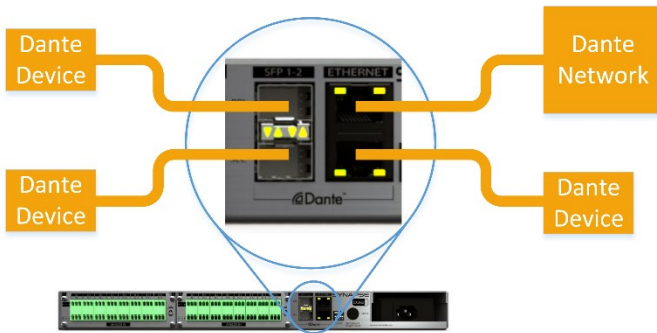

**Figure 6 - "Standalone" connection in "Switched" mode**

In “Switched” mode, the D32i reverts to using a single internal network connection with a single IP address. The concept of primary and secondary ports become irrelevant and all of the ports (both SFP and RJ45) are connected together on the same network essentially turning the D32i into a regular four port network switch.

In this mode, the Dante network can be connected to any of the four ports. Any unused ports may then be used to connect other devices in a daisy chain. As the D32i is acting as a switch, other devices connected to the D32i must then count the D32i as a switch hop.

### 3 – Device Operation

Certain features of the DM1 such as channel mutes, output level, and front panel lockout are controlled using [unlFY Control Panel application](#). Details of those features are shown in the [help documentation](#) for unlFY Control Panel.

Some features of the device are operated from the various controls on the front panel such as the main display.

### 3.1 – Display View Operation

During power up the display will show the Attero Tech logo. Once the device is running, the display will switch to showing a normal view. If there are any problems, the display will indicate a POST (Power-On Self-Test) error. If this happens contact Attero Tech technical support.

Once up and running, the front panel can show various different views and is used to control a number of D32i features. To save power, the display will turn itself off after 5 minutes of inactivity. To activate the display again, press either of the knobs to activate their buttons or the monitor select button.

*\*Note: Turning a knob will NOT turn the screen back on. It must be a button push.*

Navigating the views on the display is achieved using the “Menu Nav” knob. Rotating this left or right will step through the various views available. If the front panel lock has been activated by unlFY, the panel lock icon will be shown in the upper right hand corner of the display and while the “Menu Nav” knob can still be used to rotate the different views no further action can be taken on any view.

#### 3.1.1 – Bank Metering Views

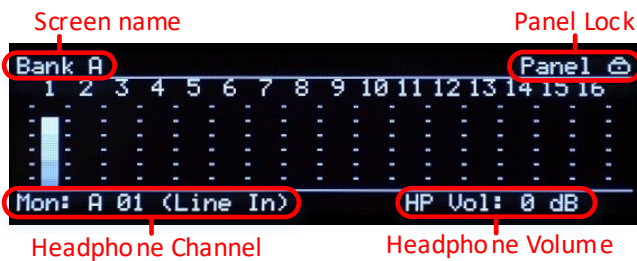

There are two views for bank metering. The main part of each bank view shows meters for each analog input in that bank. This view can be used to select the monitor output if the panel lock is not active by pressing in the “Menu Nav” button. This activates a cursor that can be scrolled used the knob to select one of the visible channels. Once the desired channel is selected, press the separate “Monitor Select” button and that channel will when be routed to the headphone output.

#### 3.1.2 – Channel Metering Views

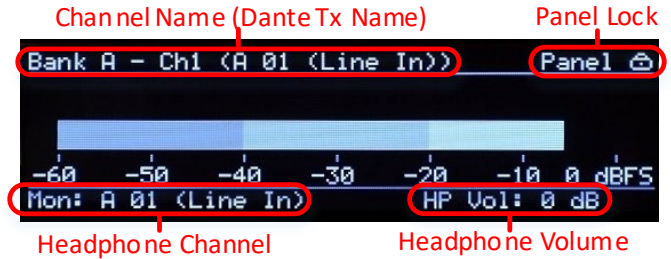

Each individual input channel has its own view. The meter itself is shown in the horizontally across the main part of the view from left to right. The name of the current channels meter being shown is displayed in the upper left hand corner. The name in parenthesis that follows the name is the channel name that this channels is identified by on the Dante network. This view can also be used to select the monitor output if the front panel lock is not active. To do so, with the desired channel on view, click the “Monitor Select” button.

#### 3.1.3 – Dante Monitor View

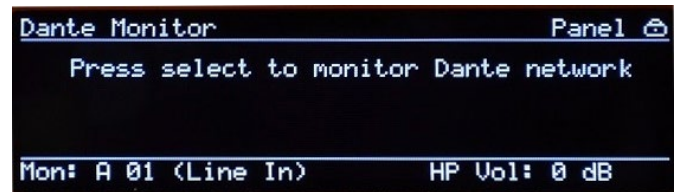

As well as monitoring the local input channels, the headphone output can also be used to monitor channels from the network. This view can be used to select Dante channels as a source for the headphone output if the front panel lock is not active. When selected, any Dante audio routed to the Dante receive channels will be heard through the headphone output.

#### 3.1.4– Network Info View

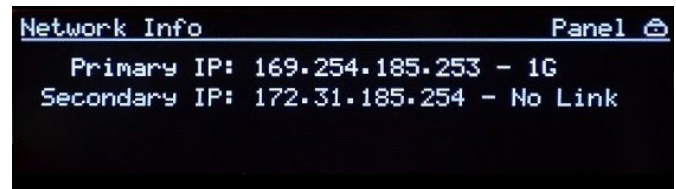

The Network info view shows the IP addresses and link speed of the D32i's interfaces. In redundant mode, both a primary and a secondary interface will be shown. The primary port speed will always indicate the faster of the two possible primary links if they are both used. The same is true the secondary port speed if both secondary links are used.

In switched mode, only one interface with its IP address is shown and the speed indicated will be the fastest speed of any of the four possible links.

### 3.1.5 – Dante Info View



The Dante info view shows information about the Dante setup. The device Dante name, its port mode and the devices clock sync status are all shown. The Dante name is name the device identifies itself as on the Dante network. The port state shows if the device is in either redundant mode or switched mode. The clock sync indicates whether the device is the “Master” clock for the system or if it’s a “Slave” to another device. A state of “No Sync” may indicate a possible problem with either the device or the network.

### 3.1.6 – Version View



The Version view gives version information about the various parts of the device.

### 3.1.7 – No Network



If the D32i becomes disconnected from the Dante network at any time, that will be indicated on various views. The metering views will show a “No Network” message while the Network view will show “No link” for all indicated interfaces.

### 3.1.8 – Identify

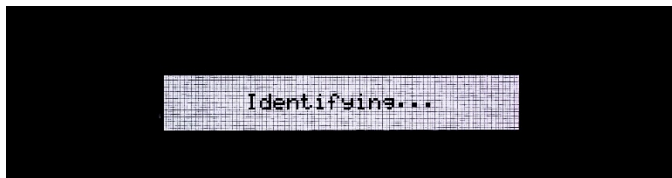

The “Identify Device” option allow devices on the network to be visually located. This feature will flash the Status/Power LED, and display the above message on the front panel display of the selected device in unIFY Control Panel. See the unIFY Control Panel manual for more information on using this function.  
*\*NOTE: On Synapse devices, the front panel controls will not operate until the Identify function is disabled.*

## 3.2 – Headphone monitoring

The D32i has a headphone output that can be used to monitor audio signals in the device. Any of the analog inputs can be monitored as well as audio supplied to the D32i by the Dante network. The currently selected channel for monitoring is shown in the bottom left corner of any of the metering views. Selecting a channel can be done from any of the metering views. The headphone output has both volume and mute controls available.

### 3.2.1 – Headphone Volume

The current volume level is indicated in the lower right corner of the display on any of the metering views. The volume is controlled with the monitor volume knob just to the right of the output jack itself. Turning the knob clockwise increases volume while turning it counter-clockwise decreases the volume level.

### 3.2.2 – Headphone Mute

The headphone volume knob also acts as a mute control. The state of the mute is indicated by the mute LED just to the left of the volume knob. The LED will be red while the mute is active and off otherwise. To toggle the mute state, push the volume knob to activate its button.

## 3.3 – Factory Reset

Should it be necessary, the D32i has a factory reset option. Activating it affects both Dante and non-Dante settings of the device. All Dante settings are reset including device name and channel names, the Ethernet port mode will be defaulted back to redundant mode and the IP address setup will be reset to get an IP address dynamically.

The factory reset switch is accessed through a small hole on the front panel. The active the factory reset insert a paperclip or small screw driver into the factory reset hole and press and hold the factory switch for five seconds. Once the switch has been in for long enough, if the screen was active, the screen will blank, releasing the switch after 5 seconds will then start the factory reset process.

## 3.4 – Firmware Updates

If a firmware update for the D32i is released, it may be applied in the field by the end user or installer. The update process takes advantage of the smart firmware update tool in unIFY. The latest firmware .SFU files can be downloaded from the [Attero Tech Product Firmware](#) page on the QSC website.

To apply the update, download the appropriate SFU file for the DM1, select the smart firmware update option under the Tools menu and follow the instructions. Further assistance for doing updates is provided in the unIFY Control Panel manual.

## 3.5 – Third Party Control

The D32i offers some support for real time third party control. Information on the commands the Synapse D32i supports, as well as details of how to use the 3<sup>rd</sup> party UDP interface are available for download from [Synapse D32i product page](#) on the QSC website.

## ARCHITECTS & ENGINEERS SPECIFICATION

The Dante™ interface shall have 32 balanced line level inputs available on terminal blocks.

The input sensitivity shall be configurable in 16 channel banks for connectivity to pro (+4 dBu nominal) or consumer (-10 dBV nominal) line level inputs.

The front panel display shall show audio inputs and allow assignment of any analog input to the front panel mounted headphone jack for monitoring.

The Dante™ interface shall support a switched or redundant network mode.

The device shall support AES67 audio network interoperability.

The device shall have two integrated Gigabit Ethernet ports on RJ-45 connectors and 2 gigabit SFP expansion slots for connectivity to a Dante network.

All parameter changes will be non-volatile and self-restoring in the event of power interruption.

The device shall support power redundancy.

The device shall be compliant with FCC 47CFR parts 15B and 18 (Class A), EN 55011, ICES-003, RoHS and CE (EN55022 Class A and EN55024 Class A).

The device shall be the Attero Tech Synapse D32i.

## Device Specifications

Analog Audio Inputs (Terminal Block)	
Input Type	32 - Balanced 3-pin line level (Terminal Block option) 4 - TASCAM-pinout compatible DB25 balanced analog (DB-25)
Input Impedance	10 kΩ (Pad Inactive) / 50 kΩ (Pad Active)
Maximum Input Levels	+24 dBu (+/- 0.5 dB) , Pad Inactive +10 dBV (+/- 0.5 dB) , Pad Active
THD+N	< 0.005 %
Dynamic Range	> 105 dB
Frequency Response	20-20kHz, +/- 0.5dB
Headphone Output	
Output Type	Stereo headphone on ¼" TRS
Maximum output level	15mW into 32 Ohms
THD+N	< 0.01 % @ 15mW
Dante Network	
Physical Layer	Ethernet
Connector (s)	Dual RJ-45 / Dual SFP Slots
Cable Quality	CAT-5e or better (Copper) / Fiber
Transmission Speed	All interfaces 1 Gbps
Supported Sample Rates	44.1 kHz / 48kHz / 88.2 kHz / 96 kHz
Minimum Dante Network Latency	250 us
Supported Modes	Redundant / Switched
AES67 Support	Dante - AES67 Mode

Power Specifications	
AC Power	120V AC
Power Consumption	< 20W Max
Cable Quality	CAT-5e or better
Physical Dimensions	
Width	19"
Height	1.75" (1 RU Form Factor)
Depth	12.5"
Weight	6 lbs
Regulatory Compliance	
Certifications	FCC CFR 47 Parts 15B Class A, EN55011 ICES-003 CE (EN55022 / EN55024) RoHS REACH
Environmental Operating Specifications	
Operating Temperature	0 to 40° C